

WE MAKE SUMMER

COMMERCIAL PARASOLS

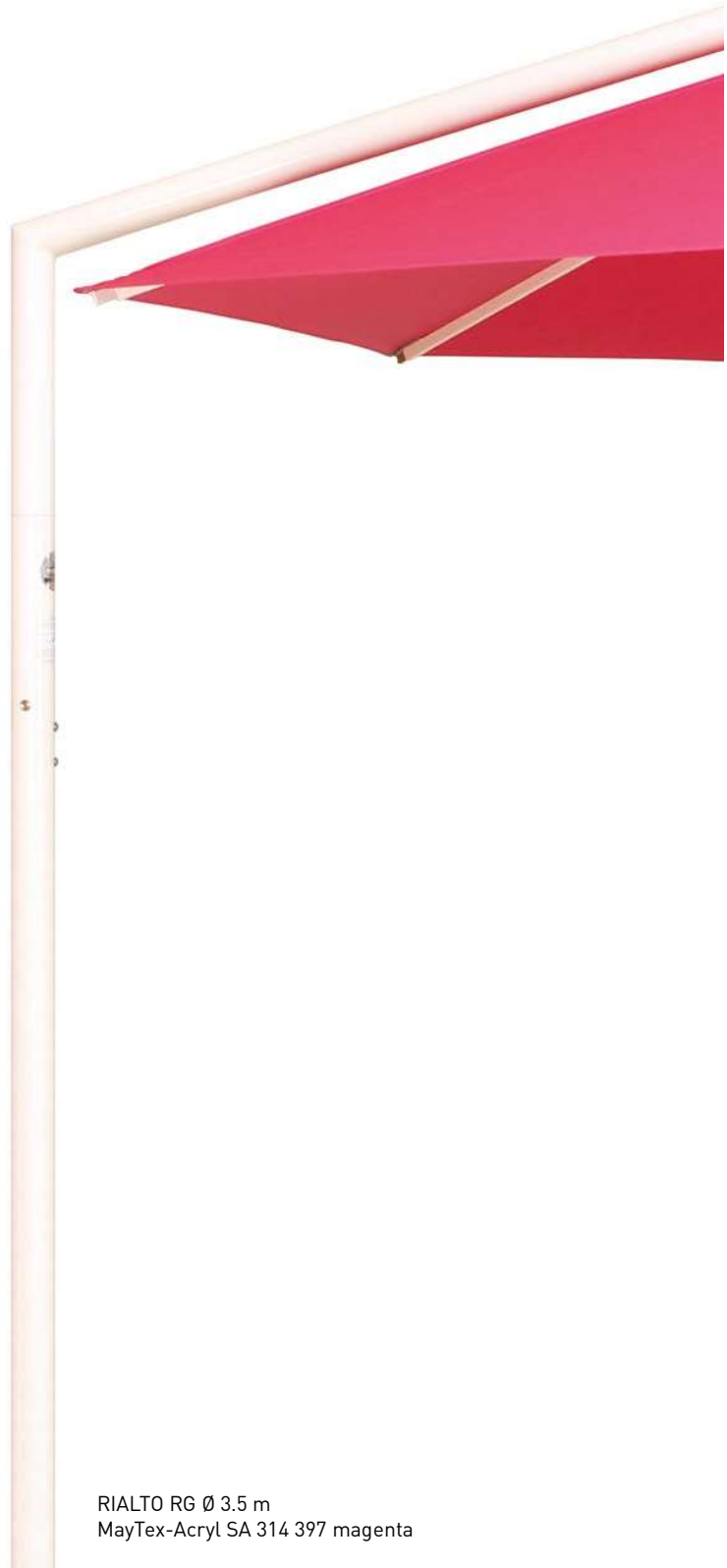

RIALTO



EXCLUSIVE

SIDE-POST PARASOL

Stylish

Designer parasol grouping

Optional pivot system



RIALTO RG Ø 3.5 m
MayTex-Acryl SA 314 397 magenta

Atmosphere and architectural style – both indoors and outside

This impressive parasol concept can be put to a variety of uses to suit private, public or business requirements. Furthermore, it can create a welcoming ambience in large-area squares, exhibitions, stylish venues and foyers.



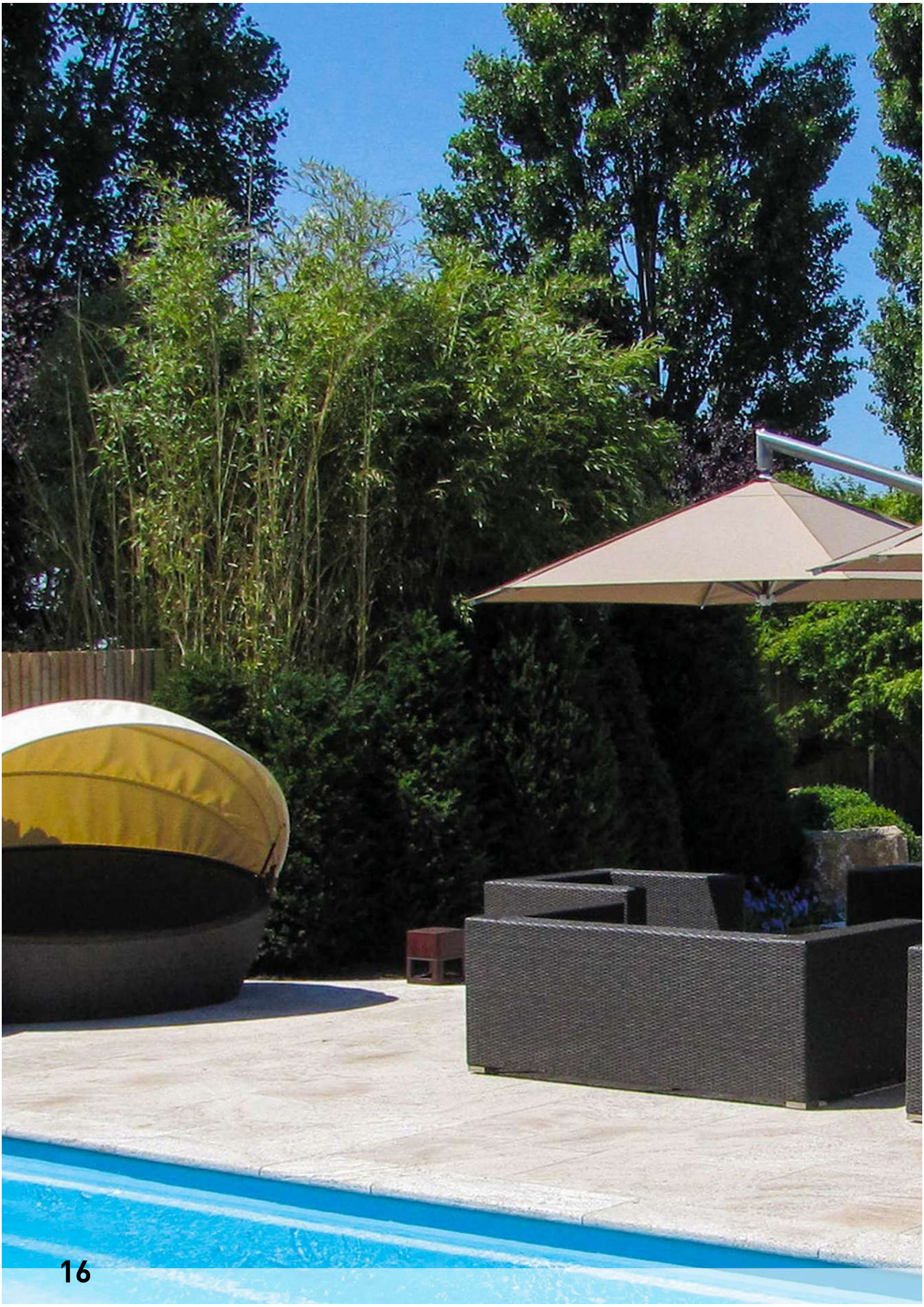

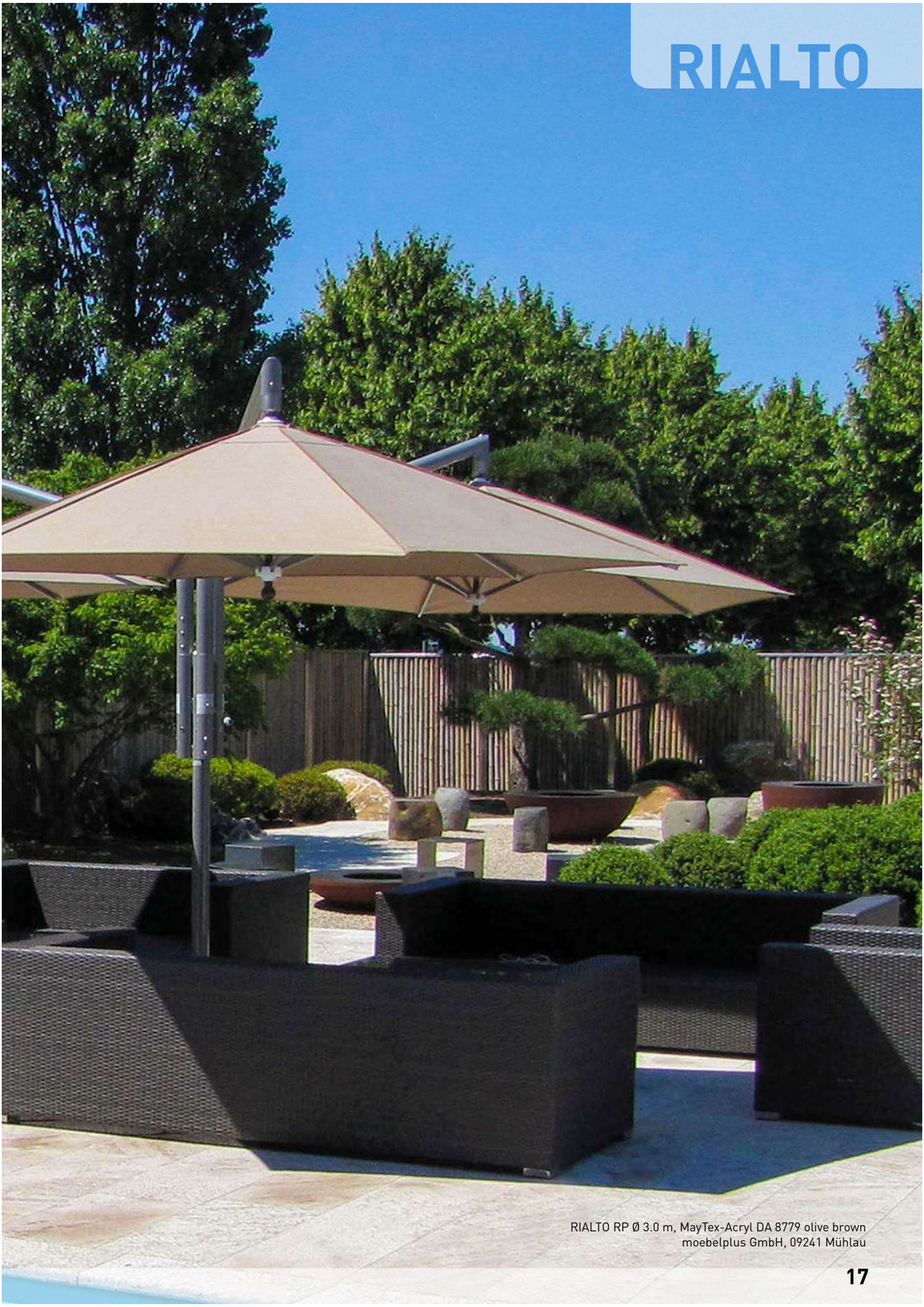

RIALTO RP Ø 3.0 m, MayTex-Acryl DA 8779 olive brown
moebelplus GmbH, 09241 Mühlau

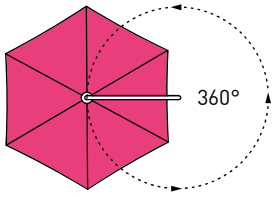

360° Rotation

All our anchoring systems are equipped with a special clamp that allows the parasol to be rotated completely to follow the path of the sun.

Shade grouping

Specially designed for large-area outdoor catering. The sturdy RIALTO mast can hold up to four elegantly grouped shades. A real eye-catcher for the patio with a difference!

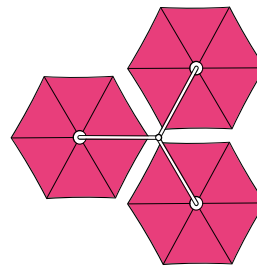

Valance options



Straight valance



Without valance

Canopy covering

Due to a self-tensioning telescopic spring system, the canopy remains perfectly taut, even after years of usage. The canopy covering can easily be exchanged by means of a practical hooking system.







Operating the parasol

with removable stainless steel crank (AISI 304, 1.4301).



Framework materials

Frame surfaces are powder-coated, highly impact-proof, and available in pure white RAL 9010.

Standard colour:

- RAL 9010 pure white

Special colours available on request.



When not in use

The protective cover provided can be easily slipped over the parasol during bad weather periods.

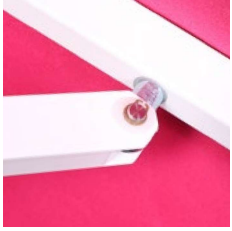

Frame joints

For us perfection in workmanship is an absolute must. Therefore, all moving axes are fitted with bolts. This extravagant technology ensures maximum stability and durability as well as easy execution of repairs.

The frame

The poles of our parasols are all made of high-quality alloyed, extruded aluminium profiles.

- support pole $\varnothing 76 \times 3$ mm
- spoke dimensions $30 \times 15 \times 2$ mm / $25 \times 15 \times 2$ mm
- support strut dimensions $20 \times 15 \times 2$ mm



The operating instructions

Proper handling of the product ensures a long life expectancy. Benefit from our 30 years of experience:

Operating instructions

- RIALTO - standard model: may.ag/RG_en.pdf
- RIALTO - canopy with pivot system: may.ag/RP_en.pdf



Fabrics and colours

Choose from over 70 contemporary textile designs, available in three different fabric types:

- MayTex-Poly, 230 g/m², water column > 1.000 mm
- MayTex-Acryl, 300 g/m², water column 370 mm
- MayTex-PVC, 480 g/m², water column > 1.000 mm
- Other fabrics and colours available at any time on request
- Textiles with fire certification (A or B1) on request

See page 220 for further information.

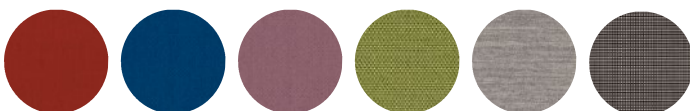

RIALTO RP – canopy with pivot system

The parasol can be moved and adjusted to the position of the sun with a removable crank. Thanks to an innovative pivot system the parasol can smoothly be tilted to an angle of max. 30° and rotated completely. The canopy is fixed by turning the crank clockwise.



Crank to fix the tilted canopy



Pivot system



Flexible tilt function (max. 30°)



Wall mount for strain relief





RIALTO RG Ø 3.0 m
MayTex-Acryl DA 7560 light yellow
without valance



straight valance



RIALTO RG 3.0 x 3.0 m
MayTex-Acryl SA 314 364 telegrey/white
without valance



straight valance



continuous valance

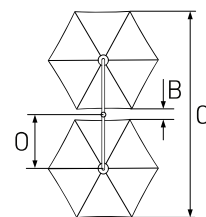
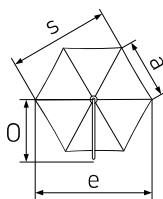

RIALTO RG round		Single with 6 segments			Double with 6 segments			
e	m	Ø 3.0	Ø 3.5	Ø 4.0	Ø 3.0	Ø 3.5	Ø 4.0	
Area	m ²	5.9	8	10.4	11.8	15.9	20.8	
a	cm	150	175	200	150	175	200	
s	Width across flats	cm	260	300	345	260	300	345
B	cm				90	53	45	
C	cm				610	660	740	
O	cm	170	190	220	175	190	220	
P	Arc length	cm	185	205.6	234	185	205.6	234
Q	cm	20	15	20	15	15	20	
R	cm	155	180	205	155	180	205	
	Weight without packaging MayTex-Acryl without valance	kg	27	29	31	49	54	58
	Support pole diameter	mm	outer Ø 76, pole thickness 3					
	Installation base length/width/min. depth	cm	50/50/60			60/60/60		
	Minimum-ballast Number of layers of concrete slabs XZ50 required		1 x = approx. 112 kg			2 x = approx. 224 kg		

The heights specified are for parasols with MayTex-Acryl covering fabric that are mounted in an anchor tube (RZ118, RZ121). The increase in height for parasols with other installation bases can be seen in the list below:

Full frame pedestal: RZ111 + 14 cm Full frame pedestal: RZ116 + 23.5 cm
 Full frame pedestal: RZ112 + 16.5 / 19.5 cm Anchor plate: RZ123 + 5 cm
 Full frame pedestal: RZ114 + 21 cm

3D view of installation base with top plate for winter protection. Base must be frost-proof and enlarged if the ground is unstable.

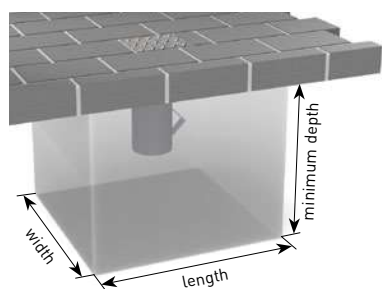

	m	Ø 3.0	Ø 3.5	Ø 4.0
K	cm	100	75	55
L	cm	205	205	205
M	cm	205	205	205
N1 without valance	cm	270	280	285
N2 with valance	cm	290	300	305
T crank height	cm	143	148	153
J	cm	170	170	175

Dimensional tolerance approx. ±5%. All measurements are to be understood as approximate.

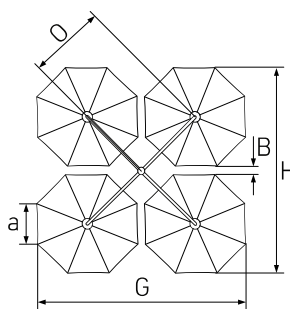
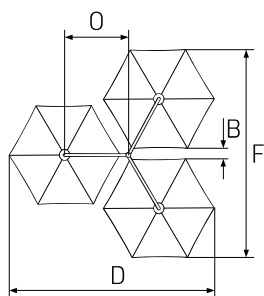

	Triple with 6 segments			Quad with 8 segments		
e	Ø 3.0	Ø 3.5	Ø 4.0	Ø 3.0	Ø 3.5	Ø 4.0
	17.7	23.9	31.2	25.5	34.6	45.2
a	150	175	200	115	134	153
s	260	300	345	275	325	360
B	50	40	40	40	25	20
D = F	570	650	740			
G = H				600	675	760
O	175	190	220	220	240	270
P	185	205.6	234	234	260	295
Q	15	15	20	70	65	70
R	155	180	205	120	135	155
	60	66	72	86	94	102
outer Ø 76, pole thickness 3						
60/60/60			60/60/60			
2 x = approx. 224 kg			3 x = ca. 336 kg [3rd layer with concrete slabs XZ49]			

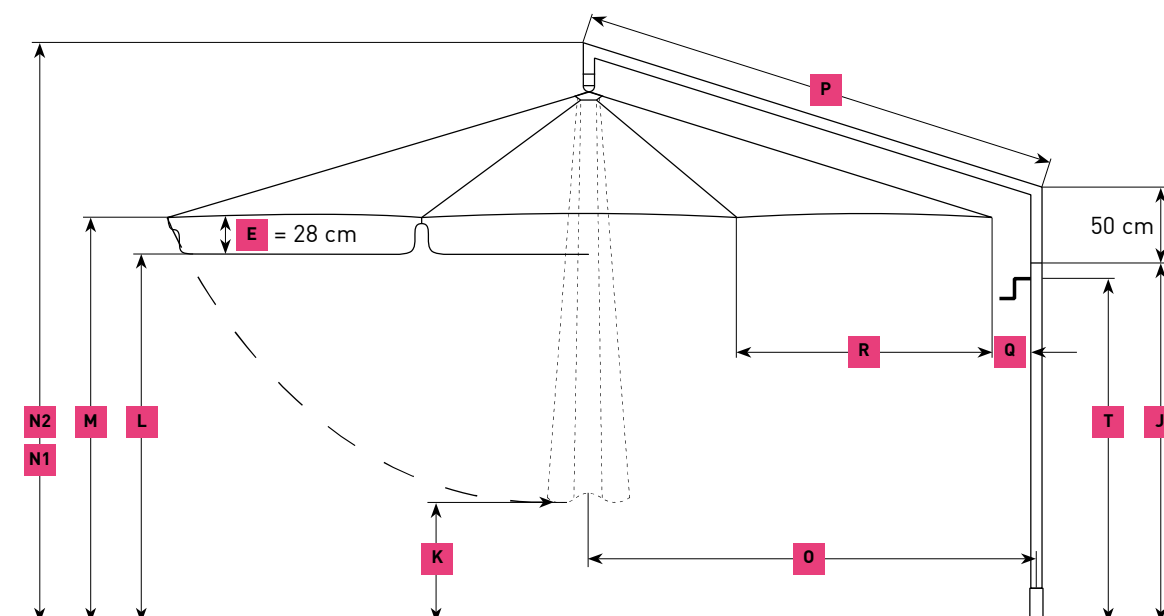

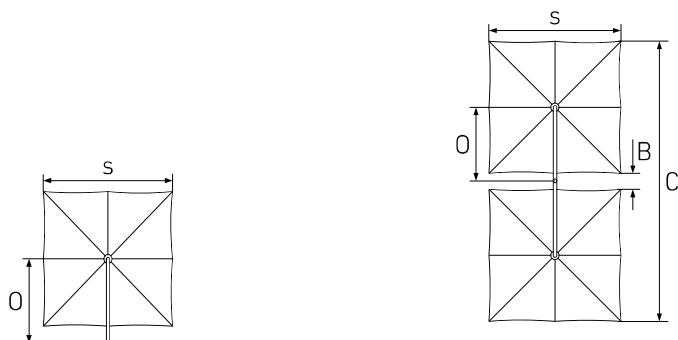

RIALTO RG square		Single with 8 segments			Double with 8 segments		
	m	2.85 × 2.85	3.0 × 3.0	3.5 × 3.5 ¹⁾	2.85 × 2.85	3.0 × 3.0	3.5 × 3.5 ¹⁾
Area	m ²	8.1	9	12.3	16.2	18	24.6
s Width across flats	cm	285	300	350	285	300	355
B	cm				72	54	38
C	cm				648	664	746
O	cm	175	175	187	183	183	195
P Arc length	cm	185	185	205.6	185	185	205.6
Q	cm	25	15	7	33	23	15
R	cm	143	152	177	143	152	177
Weight without packaging MayTex-Acryl without valance	kg	26	27	30	51	53	59
Support pole diameter	mm	outer Ø 76, pole thickness 3					
Installation base length/width/min. depth	cm	50/50/60			60/60/60		
Minimum-ballast Number of layers of concrete slabs XZ50 required		1 × = approx. 112 kg			2 × = approx. 224 kg		

¹⁾ Parasol is more difficult to open compared to the other sizes (this is due to the large roof and the high positioning of the crank).

The heights specified are for parasols with MayTex-Acryl covering fabric that are mounted in an anchor tube (RZ118, RZ121). The increase in height for parasols with other installation bases can be seen in the list below:

Full frame pedestal: RZ111 + 14 cm Full frame pedestal: RZ116 + 23.5 cm
 Full frame pedestal: RZ112 + 16.5 / 19.5 cm Anchor plate: RZ123 + 5 cm
 Full frame pedestal: RZ114 + 21 cm

3D view of installation base with top plate for winter protection. Base must be frost-proof and enlarged if the ground is unstable.

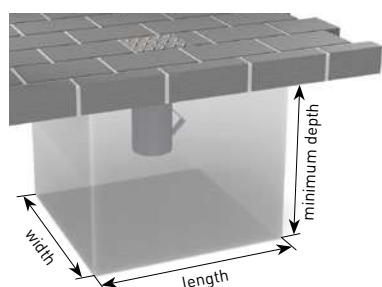

	m	2.85 × 2.85	3.0 × 3.0	3.5 × 3.5
K	cm	60	50	20
L	cm	205	205	215
M	cm	205	205	240
N1 without valance	cm	280	280	295
N2 with valance	cm	310	310	325
T crank height	cm	143	148	178
J	cm	165	170	210

Dimensional tolerance approx. ±5%. All measurements are to be understood as approximate.

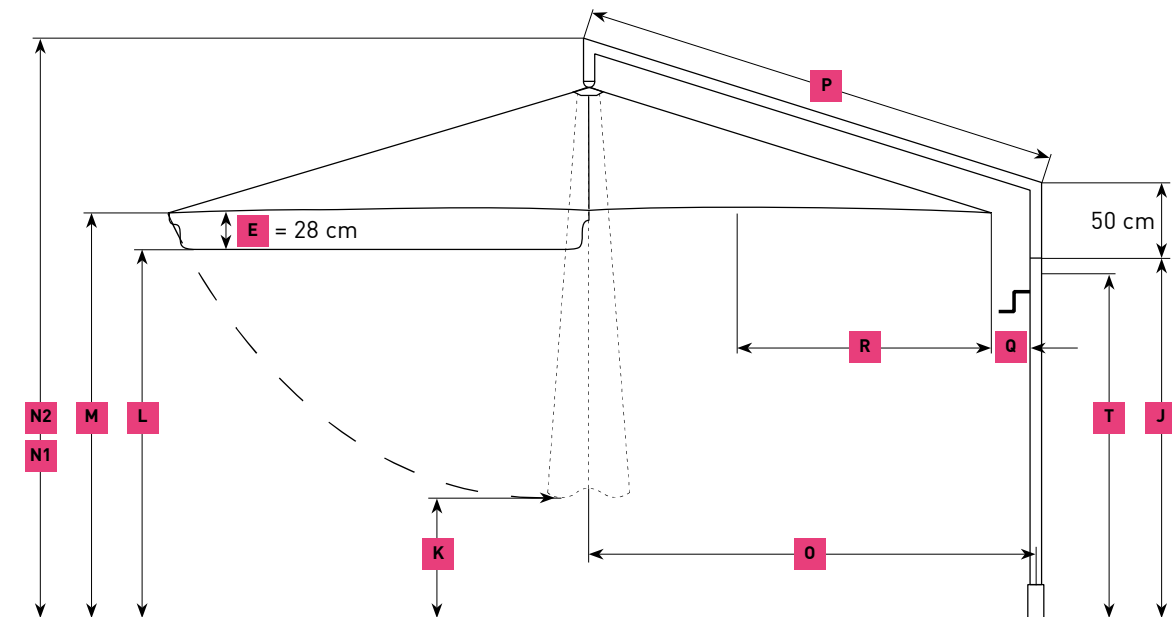

RIALTO – Accessories and Bases

Frame paint finish

Please state RAL number.

Protective cover, version zipper and aluminium rod

with zipper, grey tarp material. Please specify parasol size and valance option. Included in delivery of parasol.

art. no. **RA130**



Covering made of MayTex-PVC

approx. 480 g/m², only suitable for Ø 3 m, 2.85 × 2.85 m and 3 × 3 m.

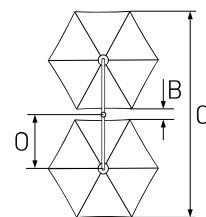
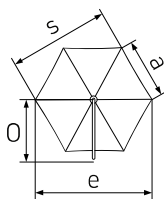

RIALTO RP round		Single with 6 segments			Double with 6 segments			
e	m	Ø 3.0	Ø 3.5	Ø 4.0	Ø 3.0	Ø 3.5	Ø 4.0	
Area	m ²	5.9	8	10.4	11.8	15.9	20.8	
a	cm	150	175	200	150	175	200	
s	Width across flats	cm	260	300	345	260	300	345
B	cm				90	53	45	
C	cm				610	660	740	
O	cm	170	190	220	175	190	220	
P	Arc length	cm	185	205,6	234	185	205.6	234
Q	cm	20	15	20	15	15	20	
R	cm	155	180	205	155	180	205	
	Weight without packaging MayTex-Acryl without valance	kg	27	29	31	49	54	58
	Support pole diameter	mm	outer Ø 76, pole thickness 3					
	Installation base length/width/min. depth	cm	50/50/60			60/60/60		
	Minimum-ballast Number of layers of concrete slabs XZ50 required		1 x = approx. 112 kg			2 x = approx. 224 kg		

The heights specified are for parasols with MayTex-Acryl covering fabric that are mounted in an anchor tube (RZ118, RZ121). The increase in height for parasols with other installation bases can be seen in the list below:

Full frame pedestal: RZ111 + 14 cm Full frame pedestal: RZ116 + 23.5 cm
 Full frame pedestal: RZ112 + 16.5 / 19.5 cm Anchor plate: RZ123 + 5 cm
 Full frame pedestal: RZ114 + 21 cm

3D view of installation base with top plate for winter protection. Base must be frost-proof and enlarged if the ground is unstable.

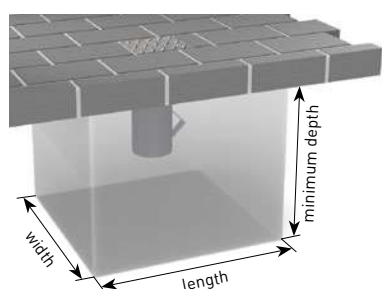

	m	Ø 3.0	Ø 3.5	Ø 4.0
K	cm	100	75	55
L	cm	205	205	205
M	cm	205	205	205
N1 without valance	cm	270	280	285
N2 with valance	cm	290	300	305
T crank height	cm	143	148	153
J	cm	175	180	185

Dimensional tolerance approx. ± 5%. All measurements are to be understood as approximate.

Constructional innovation may become necessary in the course of technical progress.

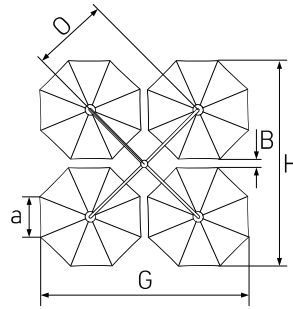
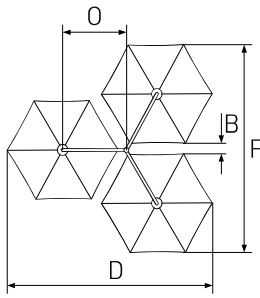

	Triple with 6 segments			Quad with 8 segments		
e	Ø 3.0	Ø 3.5	Ø 4.0	Ø 3.0	Ø 3.5	Ø 4.0
	17.7	23.9	31.2	25.5	34.6	45.2
a	150	175	200	115	134	153
s	260	300	345	275	325	360
B	50	40	40	40	25	20
D = F	570	650	740			
G = H				600	675	760
O	175	190	220	220	240	270
P	185	205.6	234	234	260	295
Q	15	15	20	70	65	70
R	155	180	205	120	135	155
	60	66	72	86	94	102
outer Ø 76, pole thickness 3						
60/60/60			60/60/60			
2 x = approx. 224 kg			3 x = ca. 336 kg [3rd layer with concrete slabs XZ49]			

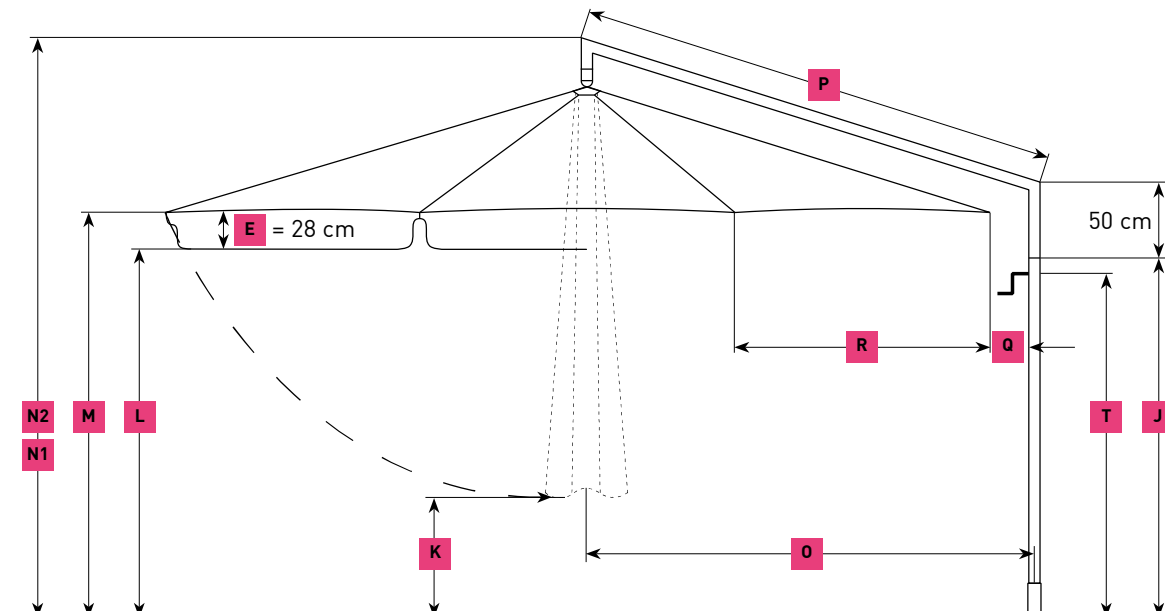

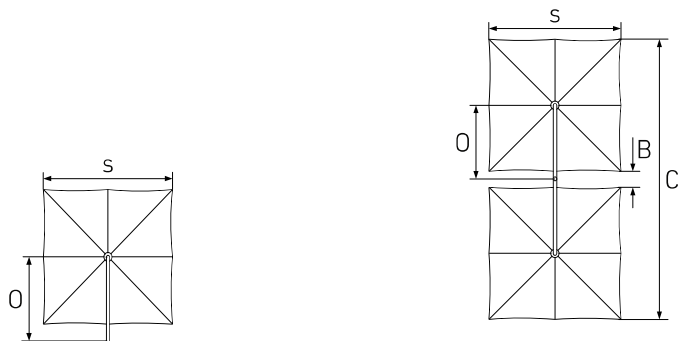

RIALTO RP square		Single with 8 segments			Double with 8 segments		
	m	2.85 × 2.85	3.0 × 3.0	3.5 × 3.5 ¹⁾	2.85 × 2.85	3.0 × 3.0	3.5 × 3.5 ¹⁾
Area	m ²	8.1	9	12.3	16.2	18	24.6
s Width across flats	cm	285	300	355	285	300	355
B	cm				72	54	38
C	cm				648	664	746
O	cm	175	175	187	183	183	195
P Arc length	cm	185	185	205.6	185	185	205.6
Q	cm	25	15	7	33	23	15
R	cm	143	152	177	143	152	177
Weight without packaging MayTex-Acryl without valance	kg	26	27	30	51	53	59
Support pole diameter	mm	outer Ø 76, pole thickness 3					
Installation base length/width/min. depth	cm	50/50/60			60/60/60		
Minimum-ballast Number of layers of concrete slabs XZ50 required		1 × = approx. 112 kg			2 × = approx. 224 kg		

¹⁾ Parasol is more difficult to open compared to the other sizes (this is due to the large roof and the high positioning of the crank).

The heights specified are for parasols with MayTex-Acryl covering fabric that are mounted in an anchor tube (RZ118, RZ121). The increase in height for parasols with other installation bases can be seen in the list below:

Full frame pedestal: RZ111 + 14 cm Full frame pedestal: RZ116 + 23.5 cm
 Full frame pedestal: RZ112 + 16.5 / 19.5 cm Anchor plate: RZ123 + 5 cm
 Full frame pedestal: RZ114 + 21 cm

3D view of installation base with top plate for winter protection. Base must be frost-proof and enlarged if the ground is unstable.

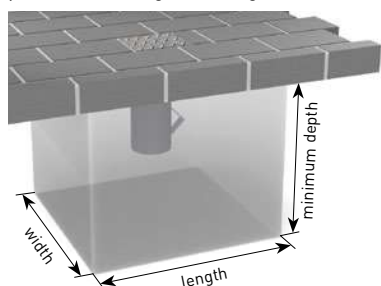

	m	2.85 × 2.85	3.0 × 3.0	3.5 × 3.5
K	cm	50	50	45
L	cm	205	205	215
M	cm	205	205	240
N1 without valance	cm	280	280	327
N2 with valance	cm	310	310	327
T crank height	cm	148	148	193
J	cm	170	175	215

Dimensional tolerance approx. ± 5%. All measurements are to be understood as approximate.

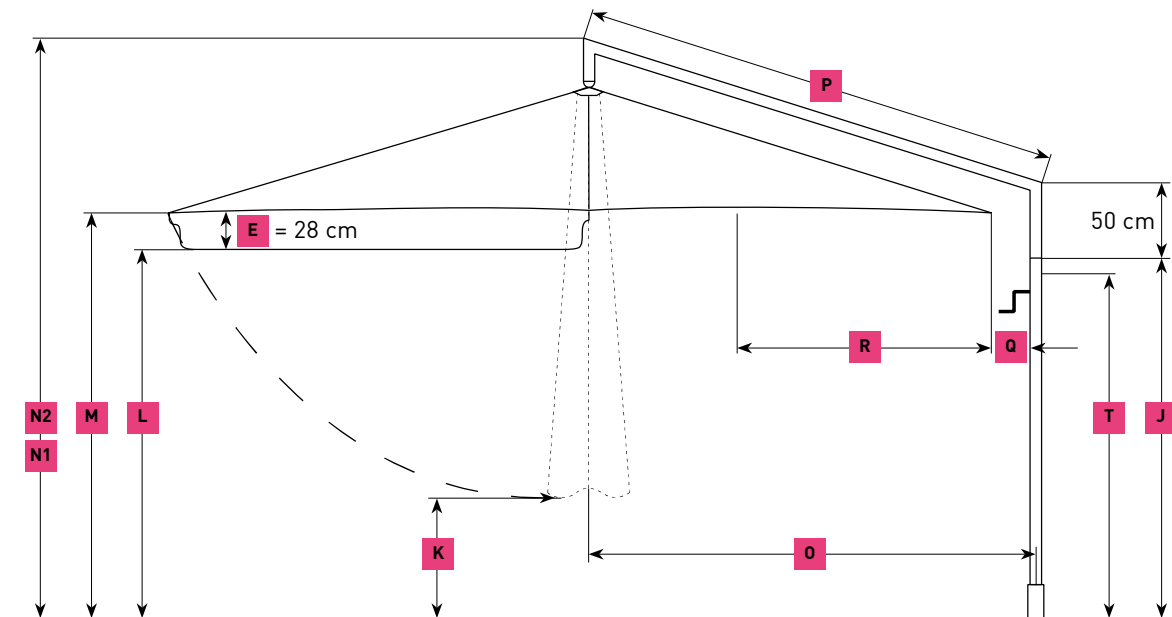

RIALTO – Accessories and Bases

Frame paint finish

Please state RAL number.

Protective cover, version zipper and aluminium rod

with zipper, grey tarp material. Please specify parasol size and valance option. Included in delivery of parasol.

art. no. **RA130**



Covering made of MayTex-PVC

approx. 480 g/m², only suitable for Ø 3 m, 2.85 × 2.85 m and 3 × 3 m.

RIALTO – mobile installation options

Full frame pedestal without slabs

frame size 103 × 103 cm, total height 29 cm, height of frame **x** = 5 cm, weight approx. 27 kg, galvanized. For 2 sets of standard concrete slabs 50 × 50 × 5 cm.

art. no. **RZ111**



Full frame pedestal without slabs

with 8 rubber diagonal support levelling screws, frame size 103 × 103 cm, total height min. 32 cm, max. 36 cm, weight approx. 28 kg, galvanized. For 2 sets of standard concrete slabs 50 × 50 × 5 cm.

art. no. **RZ112**



Full frame pedestal on wheels

with rubber heavy-duty rollers and fixing brakes, frame size 103 × 103 cm, total height 36 cm, diameter of rollers 5 cm, weight approx. 28 kg, galvanized. For 2 sets of standard concrete slabs 50 × 50 × 5 cm.

Attention: wind sensitive!

art. no. **RZ114**



Heavy-duty wheels Ø 15 cm

wheel diameter 15 cm, for uneven surfaces. Rubber, with fixing brakes, loading capacity 110 kg/wheel. Suitable for RZ414.

For orders with full frame pedestal

art. no. **351498**

For retrofitting

art. no. **351499**

Full frame pedestal on feet

for forklift or lift truck transport, frame size 103 × 103 cm, foot height **y** = 10 cm, galvanized, weight approx. 30 kg. For 2 sets of standard concrete slabs 50 × 50 × 5 cm.

art. no. **RZ116**





Concrete slabs

1 set = 4 slabs, each 50 × 50 × 5 cm, weight per slab: approx. 28 kg, total weight approx. 112 kg.

art. no. **XZ50**

RIALTO – stationary installation options

Anchor tube to be embedded in concrete

2 pieces, screw-off upper part, for single and double-shade RIALTO, galvanized, weight approx. 9 kg, incl. top plate for winter protection, **a** = 22 cm, **b** = 29 cm, **x** = Ø 17 cm, **y** = 16 cm.
Instructions: may.ag/RZ118_en.pdf

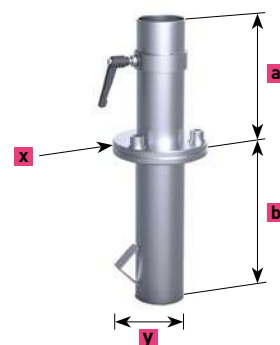

art. no. **RZ118**



RZ118 option:

Drainage unit

easy on-site installation, plastic material.

art. no. **357491**



RIALTO – stationary installation options

Anchor foot to be embedded in concrete

2 pieces, screw-off upper part, for triple-shade and quad-shade RIALTO, galvanized, weight approx. 17 kg, incl. top plate for winter protection, **a** = 23 cm, **b** = 32 cm, **x** = Ø 24 cm, **y** = 21 cm.
Instructions: may.ag/RZ121_en.pdf

art. no. **RZ121**

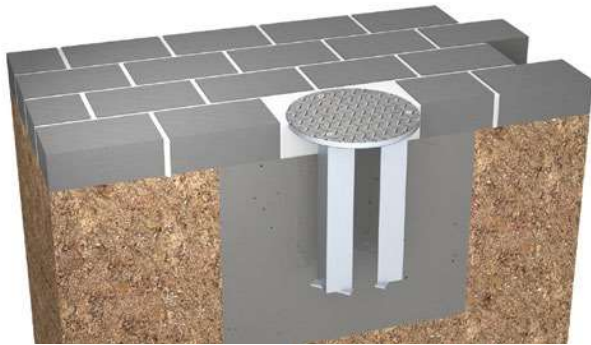
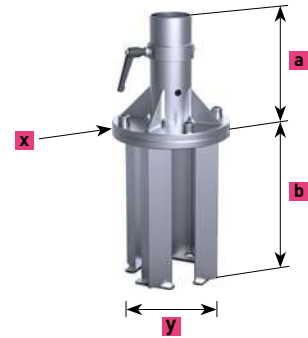

Dowel-anchored plate

galvanized, weight approx. 25 kg.
a = 25 cm, **x** = □ 50 cm, **t** = 1.2 cm, **z** = Ø 1.8 cm.

art. no. **RZ123**



Wall bracket

galvanized, weight approx. 7 kg, wall plate 30 × 20 cm, **x** = 7.2 cm, **y** = 5 cm, **t** = 1 cm. Bottom of support pole rests on bottom end of anchor tube. When ordering, please state installation height, i.e. distance from ground surface to bottom end of support mast. Otherwise it may become necessary to shorten the mast. Instructions: may.ag/RZ125_en.pdf

art. no. **RZ125**

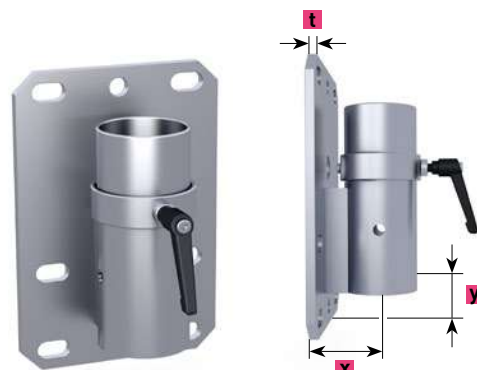

Wall pressure plate

fits for RZ125, galvanized; 30 × 20 cm; to be clamped onto the existing bars (only possible if these are very strong), bore holes for M16 stud bolts (not included in the delivery).

art. no. **352579**



RZ125 in combination with 352579

Wall mount for strain relief

to complement wall bracket RZ125, to be mounted with heavy-duty dowels at chest height.

art. no. **RZ301**



Anchor bolt

bolt and nut, fits for RZ123 and RZ125; approved for cracked and non-cracked concrete B25 to B55 (old compressive strength classes) C20/25 to C50/60 (new EU classification), also suitable for concrete B15 = C12/15 and natural stone with dense structure. Concrete bore hole \varnothing 16 × 115 mm. in stainless steel A4 1.4529. Package contains 4 bolts. European Technical Approval ETA-05/0069.

art. no. **200900**

